

## 9mm Rotary Type, Snap-In, Insulated Shaft

### Application

- ✓ TV/Video, Audio, Home appliance, Industrial control

### Feature

- ✓ Smooth rotation feeling



### ■Specification

Total Rotational Angle	RV09A series: 280±5° , RV09B series: 300±5°
Maximum Operating Voltage	50V AC
Insulation Resistance	100MΩ at DC250V
Dielectric Strength	AC250V for 1 minute
Rotational Torque	10-100 gf.cm
Click Torque	20-120 gf.cm
Rotational Stop Strength of the Shaft	3 kgs.cm min
Push/Pull Strength of the Shaft	5kgs for 3 sec
Operating Temperature Range	-10 °C~70°C
Rotation Life	With click: 5,000 cycles, without click: 10,000 cycles

### ■How to order

RV09AF-20 – 15F - B10K - 0C

[Model](#)

[Shaft Type](#)

#### Taper and Resistance Value

Order Code	Taper	Resistance Value
A100K	Log/A	100KΩ
B1M	Linear/B	1MΩ
C500K	Rev-log/C	500KΩ

Taper: A, B and C

Resistance Value: 1KΩ to 500KΩ and 1MΩ

\*Contact us for other requirements.

#### Click

Order Code	Description
Blank	No click
0C	With center click





## 9mm Rotary Type, Snap-In, Insulated Shaft

### ■ Model Description

Model	Number of Unit	Terminal Type	With Sleeve or Bushing	Rotational Angle	Mounting Height
<a href="#">RV09ACF-20</a>	Single unit	Horizontal	Sleeve	280°±5°	10 mm
<a href="#">RV09BCF-20</a>	Single unit	Horizontal	Sleeve	300°±5°	10 mm
<a href="#">RV09ACF-40</a>	Single unit	Vertical	Sleeve	280°±5°	7.0 mm
<a href="#">RV09BCF-40</a>	Single unit	Vertical	Sleeve	300°±5°	7.0 mm
<a href="#">RV09AF-20</a>	Single unit	Horizontal	N/A	280°±5°	10 mm
<a href="#">RV09AF-21</a>	Single unit	Horizontal	N/A	280°±5°	6.5 mm
<a href="#">RV09BF-20</a>	Single unit	Horizontal	N/A	300°±5°	10 mm
<a href="#">RV09BF-21</a>	Single unit	Horizontal	N/A	300°±5°	6.5 mm
<a href="#">RV09AF-40</a>	Single unit	Vertical	N/A	280°±5°	7.0 mm
<a href="#">RV09BF-40</a>	Single unit	Vertical	N/A	300°±5°	7.0 mm
<a href="#">RV09AF-20E1N</a>	Single unit	Horizontal	Plastic bushing	280°±5°	10 mm
<a href="#">RV09BF-20E1N</a>	Single unit	Horizontal	Plastic bushing	300°±5°	10 mm
<a href="#">RV09AF-40E1N</a>	Single unit	Vertical	Plastic bushing	280°±5°	7.0 mm
<a href="#">RV09BF-40E1N</a>	Single unit	Vertical	Plastic bushing	300°±5°	7.0 mm
<a href="#">RV09AF-20E1</a>	Single unit	Horizontal	Metal bushing	280°±5°	10 mm
<a href="#">RV09BF-20E1</a>	Single unit	Horizontal	Metal bushing	300°±5°	10 mm
<a href="#">RV09AF-40E1</a>	Single unit	Vertical	Metal bushing	280°±5°	7.0 mm
<a href="#">RV09BF-40E1</a>	Single unit	Vertical	Metal bushing	300°±5°	7.0 mm

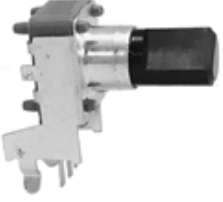
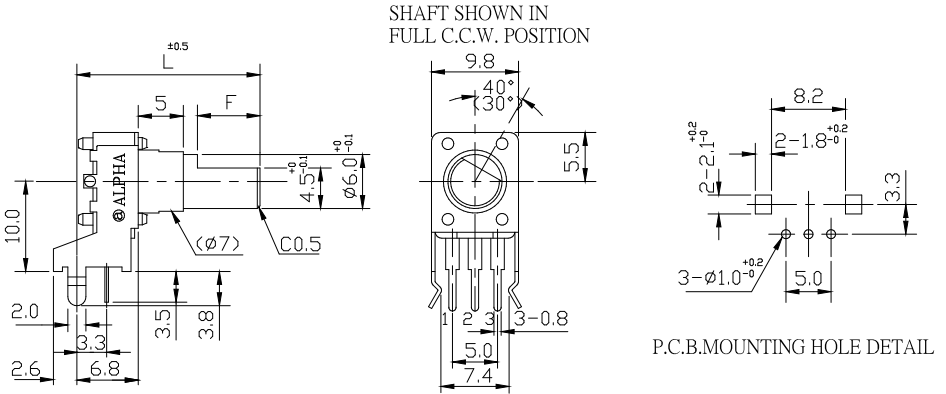

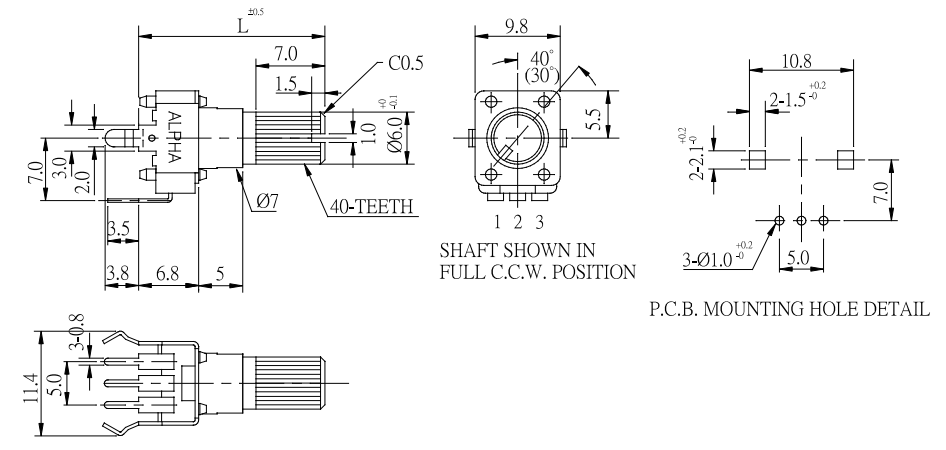
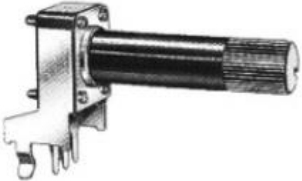
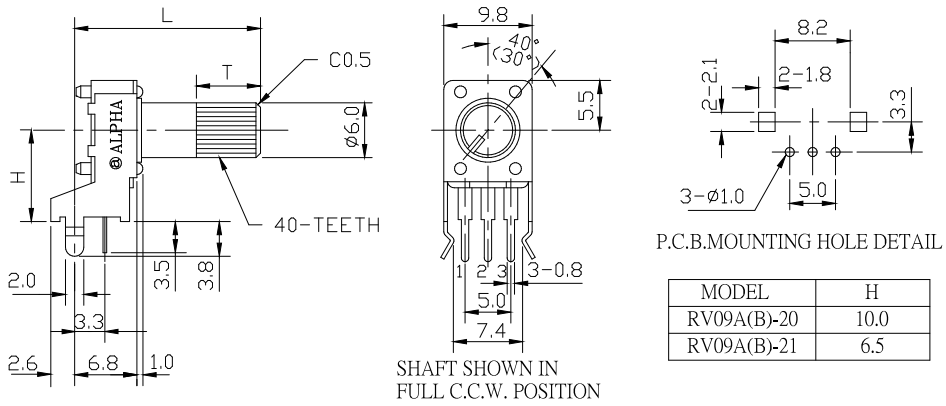

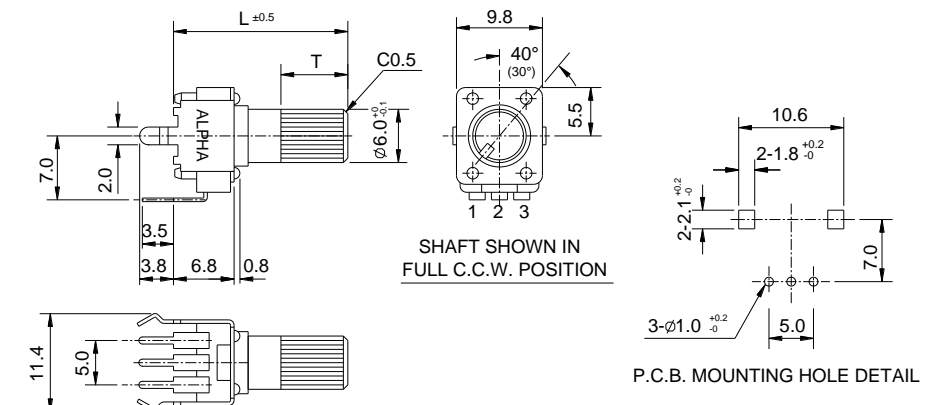

[Back to top](#)

## 9mm Rotary Type, Snap-In, Insulated Shaft

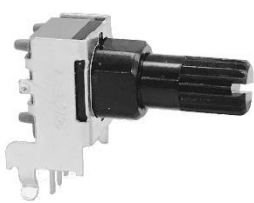
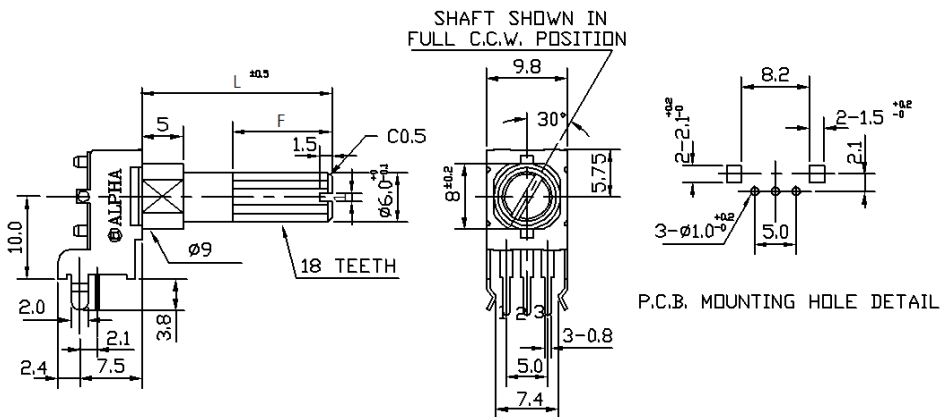
Order Code	Outline Drawing						
RV09ACF-20 RV09BCF-20 	 <p>SHAFT SHOWN IN FULL C.C.W. POSITION</p> <p>P.C.B. MOUNTING HOLE DETAIL</p>						
RV09ACF-40 RV09BCF-40 	 <p>SHAFT SHOWN IN FULL C.C.W. POSITION</p> <p>P.C.B. MOUNTING HOLE DETAIL</p>						
RV09AF-20,RV09BF-20 RV09AF-21,RV09BF-21 	 <p>SHAFT SHOWN IN FULL C.C.W. POSITION</p> <p>P.C.B. MOUNTING HOLE DETAIL</p> <table border="1" data-bbox="1228 1489 1492 1579"> <thead> <tr> <th>MODEL</th> <th>H</th> </tr> </thead> <tbody> <tr> <td>RV09A(B)-20</td> <td>10.0</td> </tr> <tr> <td>RV09A(B)-21</td> <td>6.5</td> </tr> </tbody> </table>	MODEL	H	RV09A(B)-20	10.0	RV09A(B)-21	6.5
MODEL	H						
RV09A(B)-20	10.0						
RV09A(B)-21	6.5						
RV09AF-40 RV09BF-40 	 <p>SHAFT SHOWN IN FULL C.C.W. POSITION</p> <p>P.C.B. MOUNTING HOLE DETAIL</p>						

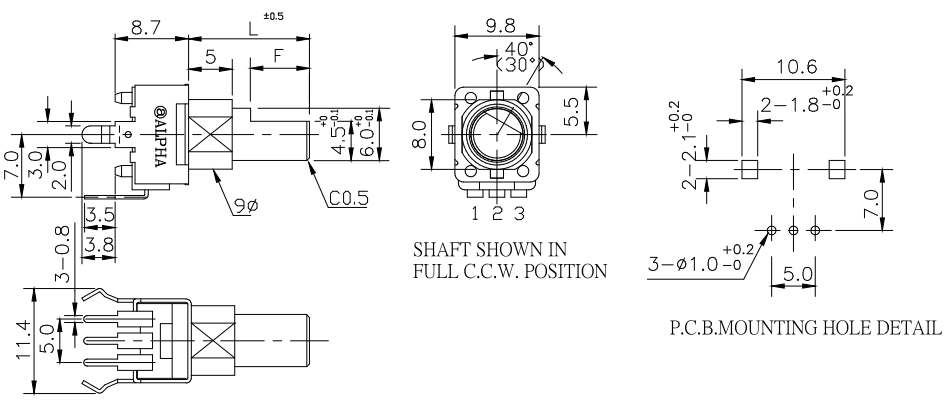
[Back to top](#)

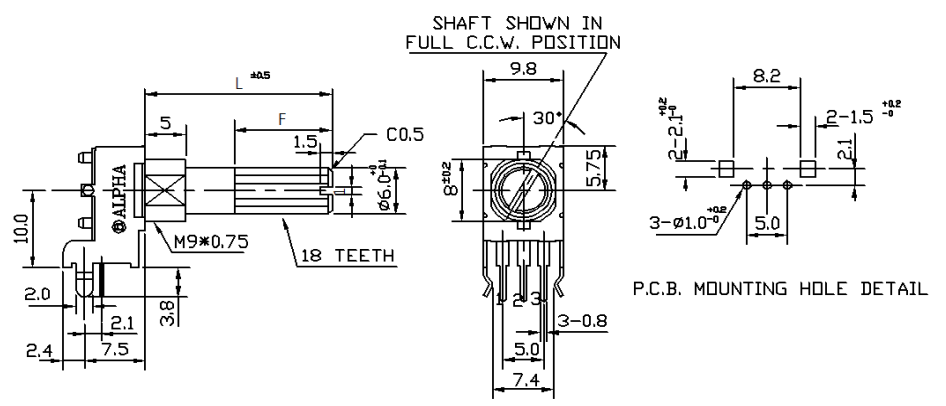
## 9mm Rotary Type, Snap-In, Insulated Shaft

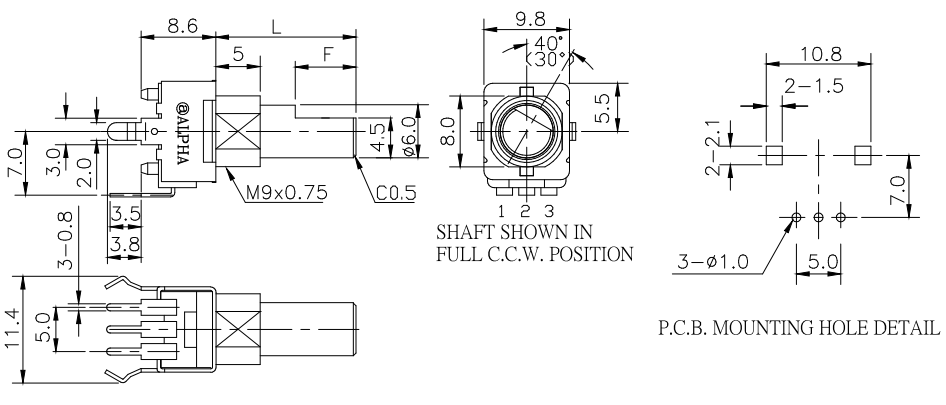
Order code	Outline Drawing
RV09AF-20E1N RV09BF-20E1N 	 <p>SHAFT SHOWN IN FULL C.C.W. POSITION</p> <p>P.C.B. MOUNTING HOLE DETAIL</p>
RV09AF-40E1N RV09BF-40E1N 	 <p>SHAFT SHOWN IN FULL C.C.W. POSITION</p> <p>P.C.B. MOUNTING HOLE DETAIL</p>
RV09AF-20E1 RV09BF-20E1 	 <p>SHAFT SHOWN IN FULL C.C.W. POSITION</p> <p>P.C.B. MOUNTING HOLE DETAIL</p>
RV09AF-40E1 RV09BF-40E1 	 <p>SHAFT SHOWN IN FULL C.C.W. POSITION</p> <p>P.C.B. MOUNTING HOLE DETAIL</p>

[Back to top](#)

## 9mm Rotary Type, Snap-In, Insulated Shaft

### ■ K TYPE

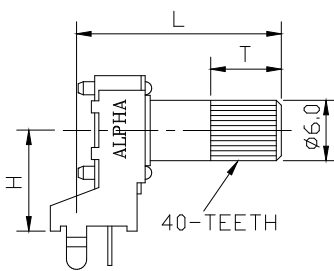
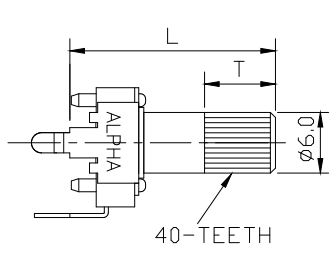
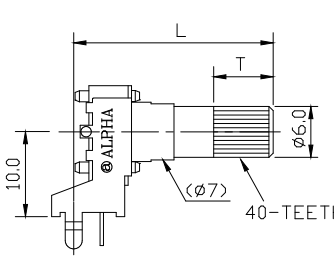
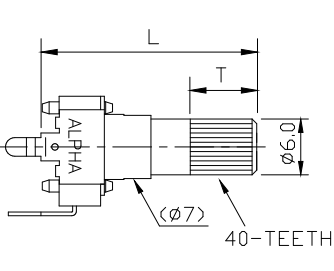
RV09AF-20(21)-(L)K RV09BF-20(21)-(L)K	RV09AF-40-(L)K RV09BF-40-(L)K	RV09ACF-20-(L)K RV09BCF-20-(L)K	RV09ACF-40-(L)K RV09BCF-40-(L)K
			

#### RV09AF, RV09ACF

Order Code	15K	20K	25K	30K
L	15	20	25	30
T	7	7	7	7

#### RV09BF, RV09BCF

Order Code	20K	25K	30K
L	20	25	30
T	7	7	7

\*\*15 mm shaft is not available for RV09ACF/BCF models.

RV09AF-20E1N-(L)K RV09BF-20E1N-(L)K RV09AF-20E1-(L)K RV09BF-20E1-(L)K	RV09AF-40E1N-(L)K RV09BF-40E1N-(L)K RV09AF-40E1-(L)K RV09BF-40E1-(L)K
--	--

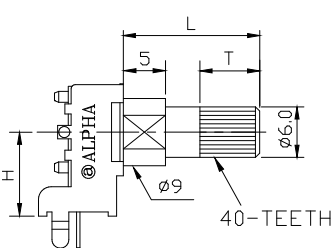
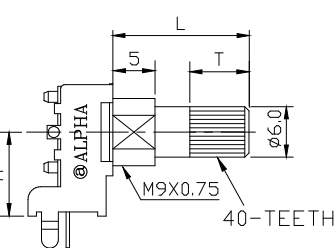
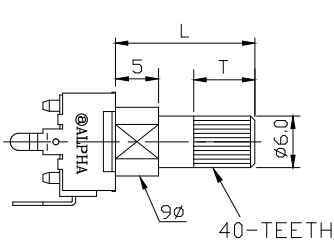
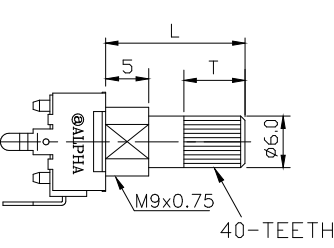
			
H=10			

Order Code	165K	215K
L	16.5	21.5
T	7	7

[Back to top](#)

## 9mm Rotary Type, Snap-In, Insulated Shaft

### ■ F TYPE

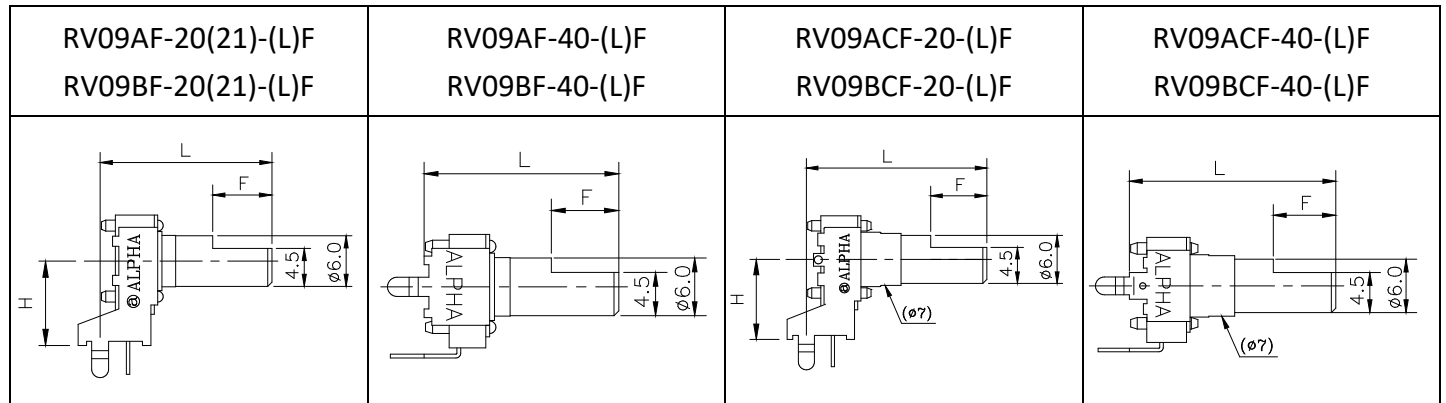

#### RV09AF, RV09ACF

Order Code	*15F	20F	21F	25F	26F	30F
L	15	20	21	25	26	30
F	6	7	7	7	12	12

#### RV09BF, RV09BCF

Order Code	*15F	20F	21F	235F	25F	26F	31F	35F	375F
L	15	20	21	23.5	25	26	31	35	37.5
F	6	7	7	7	7	8.25	12	12	12

\*\*15 mm shaft is not available for RV09ACF/BCF models.

RV09AF-20E1N-(L)F  
RV09BF-20E1N-(L)F  
RV09AF-20E1-(L)F  
RV09BF-20E1-(L)F

RV09AF-40E1N-(L)F  
RV09BF-40E1N-(L)F  
RV09AF-40E1-(L)F  
RV09BF-40E1-(L)F

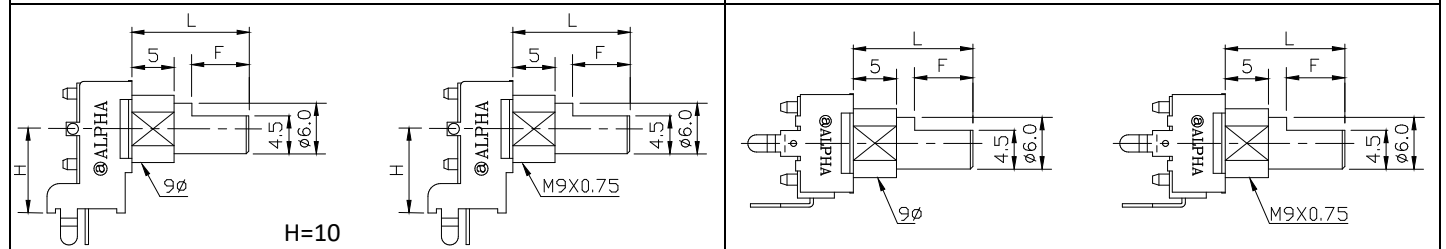

#### RV09AF

Order Code	115F	125F	165F	175F	215F
L	11.5	12.5	16.5	17.5	21.5
F	6.5	7	7	12	12

#### RV09BF

Order Code	115F	125F	15F	165F	165F	165F	175F	215F	225F	265F	29F
L	11.5	12.5	15	16.5	16.5	16.5	17.5	21.5	22.5	26.5	29
F	6.5	7	7	7	8.25	12	12	12	12	12	12

[Back to top](#)

## 9mm Rotary Type, Snap-In, Insulated Shaft

### ■ B TYPE

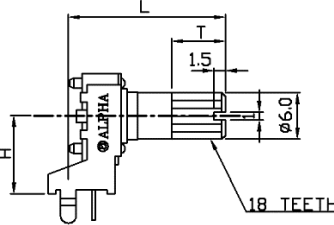
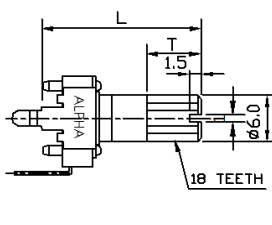
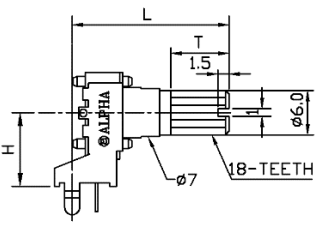
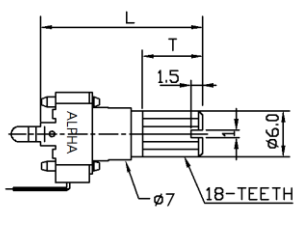
RV09AF-20(21)-(L)B RV09BF-20(21)-(L)B	RV09AF-40-(L)B RV09BF-40-(L)B	RV09ACF-20-(L)B RV09BCF-20-(L)B	RV09ACF-40-(L)B RV09BCF-40-(L)B
			

#### RV09AF, RV09ACF

Order Code	20B	25B
L	20	25
T	7	7

#### RV09BF, RV09BCF

Order Code	20B	25B	30B	33B
L	20	25	30	33
T	7	7	7	7

\*\*15 mm shaft is not available for RV09ACF/BCF models.

RV09AF-20E1N-(L)B RV09BF-20E1N-(L)B RV09AF-20E1-(L)B RV09BF-20E1-(L)B	RV09AF-40E1N-(L)B RV09BF-40E1N-(L)B RV09AF-40E1-(L)B RV09BF-40E1-(L)B
--	--

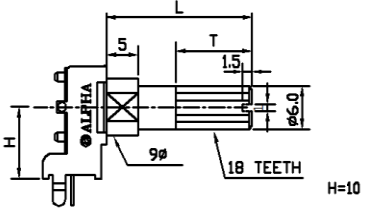
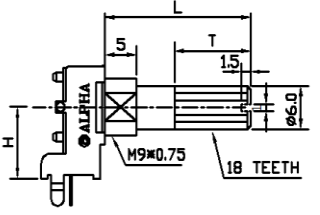
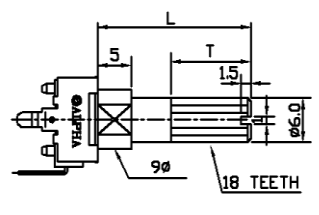
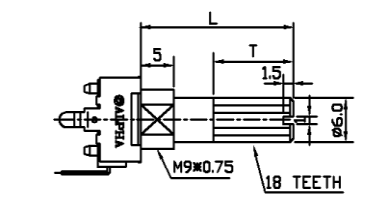
			
--	---	--	---

RV09AF	RV09BF																								
<table border="1"> <thead> <tr> <th>Order Code</th> <th>115B</th> <th>165B</th> </tr> </thead> <tbody> <tr> <td>L</td> <td>11.5</td> <td>16.5</td> </tr> <tr> <td>T</td> <td>7</td> <td>7</td> </tr> </tbody> </table>	Order Code	115B	165B	L	11.5	16.5	T	7	7	<table border="1"> <thead> <tr> <th>Order Code</th> <th>115B</th> <th>165B</th> <th>215B</th> <th>25B</th> </tr> </thead> <tbody> <tr> <td>L</td> <td>11.5</td> <td>16.5</td> <td>21.5</td> <td>25</td> </tr> <tr> <td>T</td> <td>7</td> <td>7</td> <td>7</td> <td>7</td> </tr> </tbody> </table>	Order Code	115B	165B	215B	25B	L	11.5	16.5	21.5	25	T	7	7	7	7
Order Code	115B	165B																							
L	11.5	16.5																							
T	7	7																							
Order Code	115B	165B	215B	25B																					
L	11.5	16.5	21.5	25																					
T	7	7	7	7																					

Design and specifications presented here are for the standard parts only. Please kindly contact us for your special requests and ask for the current technical specifications before purchase and/or use.

[Back to top](#)